

# FORSITE

MAILBOXES, SIGNS & SITE AMENITIES



1-855-537-0200  
www.mailboxesandsigns.com



## WHY FORSITE?

### 1. Best Products, Best Value:

Attractive selection, rust free cast aluminum construction and durable powder coated finishes.

### 2. Experience:

Since 2007, Forsite has provided exceptional products and great service. The Forsite team has over 70 years combined experience in the mailbox and signage business.

### 3. Custom Design and Manufacturing:

Create your mailbox system or street sign assembly by choosing from our many styles of posts, bases and accessories.

### 4. Expert Installation:

Experienced and insured crews able to provide expert installation of our products nationwide.

### 5. Return on Investment:

Enhance the value of your property or community with high quality and durable products that will last for years to come.

### 6. Refurbishment Services Available:

Have existing mailboxes, lighting or signage that needs refurbished or repaired? We can help.

### 7. Project Pricing:

Contact Forsite to receive the best possible pricing for your projects.

# TABLE OF CONTENTS

## DECORATIVE TRAFFIC SIGNAGE

• Vista Series . . . . .	5
• Classic Series . . . . .	6
• Town Square Series . . . . .	7
• Country Lane Series . . . . .	8
• Springfield Series . . . . .	9
• How To Configure Your Signage System	
• Poles / Pole Toppers / Bases . . . . .	10
• Street Sign Mounts and Banner Arm Styles . . . . .	11
• Custom Sign Mounts . . . . .	12
• Pole Top Mounting Brackets and Finials . . . . .	12
• Traffic Sign Back Plates, Sign Trims and Sign Frames . . . . .	13
• Street Name Sign Blades / MUTCD Approved Signage . . . . .	14
• Breakaway Poles . . . . .	15

## WAYFINDING AND ENTRANCE SIGNS

• Custom Wayfinding and Entrance Signs . . . . .	16 - 19
--	---------

## CURBSIDE MAILBOX SYSTEMS

• Ashley . . . . .	21
• Atlantic . . . . .	22
• Austin . . . . .	23
• Bel-Aire . . . . .	24
• Bradford . . . . .	25
• Hempfield . . . . .	26
• Pacific . . . . .	27
• Palms . . . . .	28
• Seaside . . . . .	29
• Sinclair . . . . .	30
• Sorrento . . . . .	31
• Wingate . . . . .	32
• How To Configure Your Mailbox System . . . . .	33

## ADDITIONAL MAILBOX SYSTEMS

• Wall Mount, Curbside Mailboxes and Posts by Special Lite Products . . . . .	34
• Curbside Mailboxes and Posts by Imperial Mailbox Systems . . . . .	35
• Cluster Box Units (CBU's) by Florence Corporation . . . . .	36
• 4C Mailbox Systems by Florence Corporation . . . . .	37

## SITE FURNISHINGS

• Benches, Bike Racks, Table and Chairs, Waste Receptacles . . . . .	37
• Pet Waste Stations . . . . .	38
• Bollards . . . . .	38
• Message Boards . . . . .	38
• Commercial Lighting . . . . .	39

**DECORATIVE  
TRAFFIC SIGNAGE**



# VISTA SERIES

## DECORATIVE TRAFFIC SIGNAGE

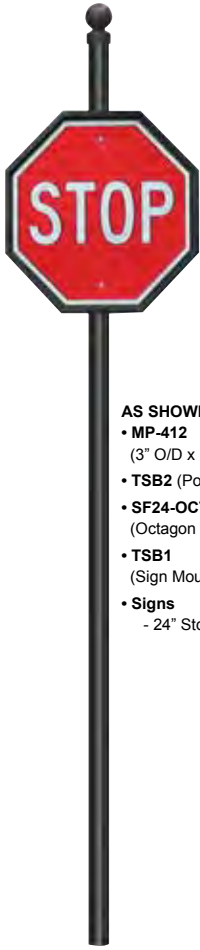

- AS SHOWN:**
- **MP-412**  
(3" O/D x 12' Fluted Pole)
  - **TSB2** (Pole Topper)
  - **SF24-OCT**  
(Octagon Sign Frame)
  - **TSB1**  
(Sign Mounting Brackets)
  - **Signs**  
- 24" Stop Sign

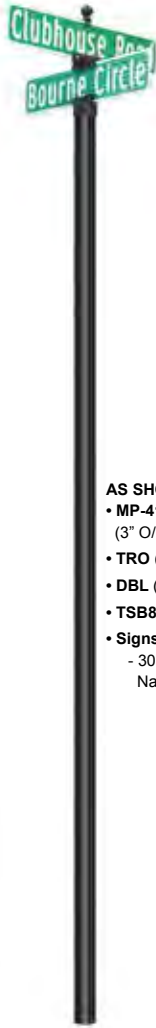

- AS SHOWN:**
- **MP-412**  
(3" O/D x 12' Fluted Pole)
  - **TRO** (Sign Bracket)
  - **DBL** (Sign Bracket)
  - **TSB8** (Finial)
  - **Signs**  
- 30" W x 6" H Street Name Signs



- AS SHOWN:**
- **MP-414**  
(3" O/D x 14' Fluted Pole)
  - **TSB2** (Pole Topper)
  - **TSCR (x2)**  
(Street Name Sign Mounts)
  - **SF24-OCT**  
(Octagon Sign Frame)
  - **TSB1**  
(Sign Mounting Brackets)
  - **Signs**  
- 30" W x 6" H Street Name Signs  
- 24" Stop Sign



- AS SHOWN:**
- **MP-414**  
(3" O/D x 14' Fluted Pole)
  - **TSB4** (Pole Topper)
  - **TSB-201-630 (x2)**  
(Street Name Sign Frames)
  - **SF24-OCT**  
(Octagon Sign Frame)
  - **TSB1**  
(Sign Mounting Brackets)
  - **Signs**  
- 30" W x 6" H Street Name Signs  
- 24" Stop Sign

- 3" O/D and 4" O/D round extruded aluminum poles
- Smooth and fluted aluminum poles with breakaway options available
- See pages 10 - 15 for how to configure details and additional accessory options

### POLE OPTIONS

- **Smooth Breakaway**  
• 3" O/D Round Pole  
• 4" O/D Round Pole
- Approved by:
- 

- **Smooth**  
• 3" O/D Round Pole  
• 4" O/D Round Pole

- **Fluted**  
• 3" O/D Round Pole  
• 4" O/D Round Pole



# CLASSIC SERIES

## DECORATIVE TRAFFIC SIGNAGE

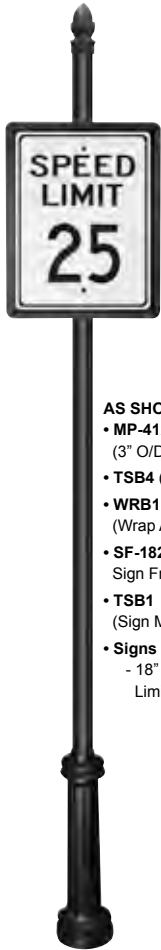

- AS SHOWN:**
- **MP-412**  
(3" O/D x 12' Fluted Pole)
  - **TSB4** (Pole Topper)
  - **WRB1**  
(Wrap Around Base)
  - **SF-1824** (Rectangle Sign Frame)
  - **TSB1**  
(Sign Mounting Brackets)
  - **Signs**  
- 18" W x 24" H Speed Limit Sign

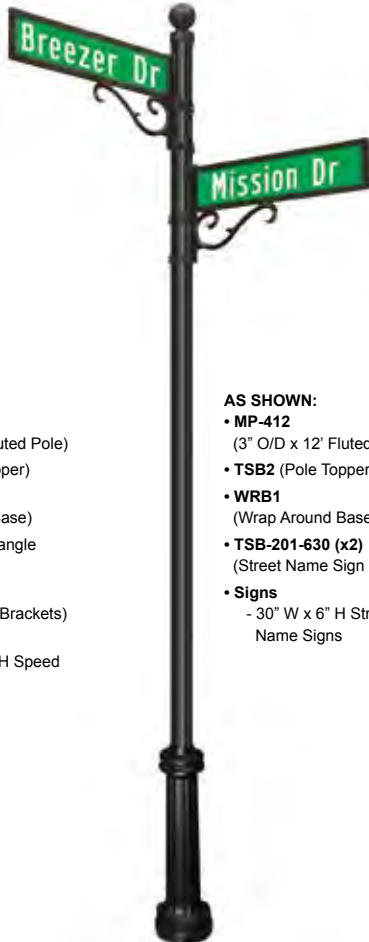

- AS SHOWN:**
- **MP-412**  
(3" O/D x 12' Fluted Pole)
  - **TSB2** (Pole Topper)
  - **WRB1**  
(Wrap Around Base)
  - **TSB-201-630 (x2)**  
(Street Name Sign Frames)
  - **Signs**  
- 30" W x 6" H Street Name Signs

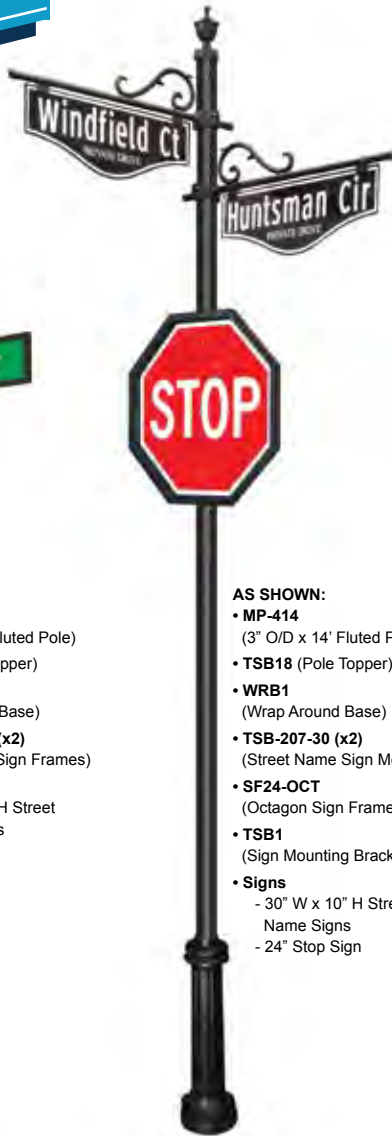

- AS SHOWN:**
- **MP-414**  
(3" O/D x 14' Fluted Pole)
  - **TSB18** (Pole Topper)
  - **WRB1**  
(Wrap Around Base)
  - **TSB-207-30 (x2)**  
(Street Name Sign Mounts)
  - **SF24-OCT**  
(Octagon Sign Frame)
  - **TSB1**  
(Sign Mounting Brackets)
  - **Signs**  
- 30" W x 10" H Street Name Signs  
- 24" Stop Sign

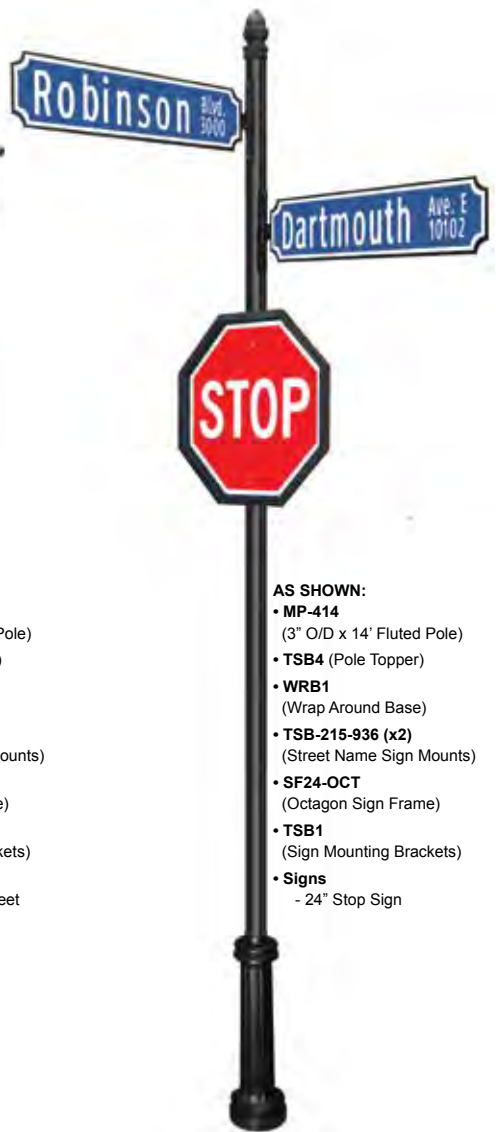

- AS SHOWN:**
- **MP-414**  
(3" O/D x 14' Fluted Pole)
  - **TSB4** (Pole Topper)
  - **WRB1**  
(Wrap Around Base)
  - **TSB-215-936 (x2)**  
(Street Name Sign Mounts)
  - **SF24-OCT**  
(Octagon Sign Frame)
  - **TSB1**  
(Sign Mounting Brackets)
  - **Signs**  
- 24" Stop Sign



- 3" O/D round extruded aluminum poles
- Smooth and fluted aluminum poles with breakaway options available
- 26" Classic Series cast aluminum base
- See pages 10 - 15 for how to configure details and additional accessory options

### BASE DETAIL

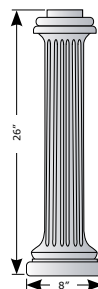

### POLE OPTIONS

- **Smooth Breakaway**  
• 3" O/D Round Pole



Approved by:

- **Smooth**  
• 3" O/D Round Pole



- **Fluted**  
• 3" O/D Round Pole



# TOWN SQUARE SERIES

## DECORATIVE TRAFFIC SIGNAGE

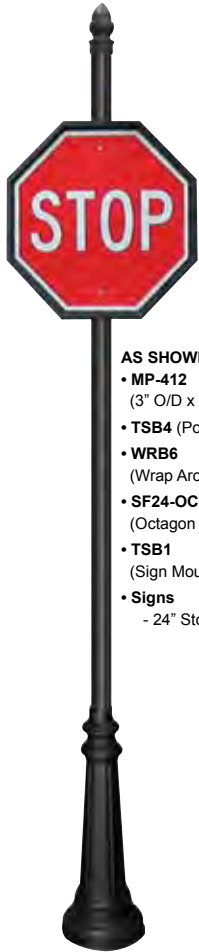

- AS SHOWN:**
- **MP-412**  
(3" O/D x 12' Fluted Pole)
  - **TSB4** (Pole Topper)
  - **WRB6**  
(Wrap Around Base)
  - **SF24-OCT**  
(Octagon Sign Frame)
  - **TSB1**  
(Sign Mounting Brackets)
  - **Signs**  
- 24" Stop Sign

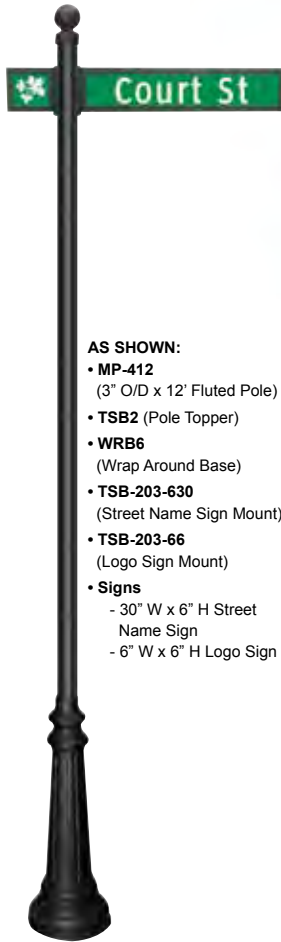

- AS SHOWN:**
- **MP-412**  
(3" O/D x 12' Fluted Pole)
  - **TSB2** (Pole Topper)
  - **WRB6**  
(Wrap Around Base)
  - **TSB-203-630**  
(Street Name Sign Mount)
  - **TSB-203-66**  
(Logo Sign Mount)
  - **Signs**  
- 30" W x 6" H Street Name Sign  
- 6" W x 6" H Logo Sign



- AS SHOWN:**
- **MP-414**  
(3" O/D x 14' Fluted Pole)
  - **TSB4** (Pole Topper)
  - **WRB6**  
(Wrap Around Base)
  - **TSB-216-936 (x2)**  
(Street Name Sign Mounts)
  - **SF24-OCT**  
(Octagon Sign Frame)
  - **TSB1**  
(Sign Mounting Brackets)
  - **Signs**  
- 24" Stop Sign



- AS SHOWN:**
- **MP-614**  
(4" O/D x 14' Fluted Pole)
  - **TSB64** (Pole Topper)
  - **WRB9**  
(Wrap Around Base)
  - **TSCR-600 (x2)**  
(Street Name Sign Mounts)
  - **SF30-OCT**  
(Octagon Sign Frame)
  - **TSB61**  
(Sign Mounting Brackets)
  - **Signs**  
- 30" W x 10 3/8" H Street Name Signs  
- 30" Stop Sign

- 3" O/D and 4" O/D round extruded aluminum poles
- Smooth and fluted aluminum poles with breakaway options available
- 32" Town Square Series cast aluminum base
- See pages 10 - 15 for how to configure details and additional accessory options

### BASE DETAIL

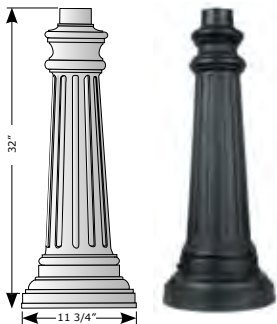

### POLE OPTIONS

- **Smooth Breakaway**  
• 3" O/D Round Pole  
• 4" O/D Round Pole
- Approved by:  
 U.S. Department of Transportation  
Federal Highway Administration
- **Smooth**  
• 3" O/D Round Pole  
• 4" O/D Round Pole
- **Fluted**  
• 3" O/D Round Pole  
• 4" O/D Round Pole

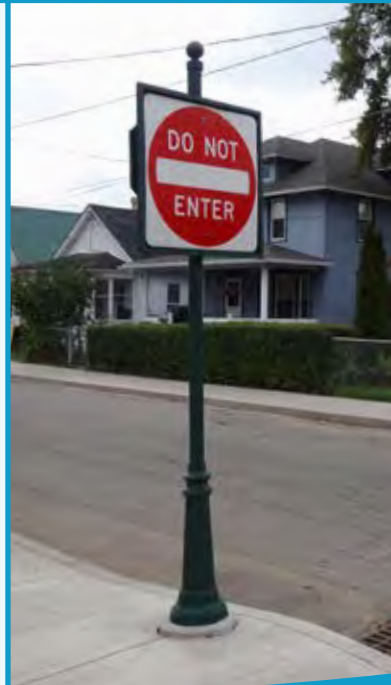

# COUNTRY LANE SERIES

## DECORATIVE TRAFFIC SIGNAGE



- AS SHOWN:**
- **MP-410**  
(3" O/D x 10' Fluted Pole)
  - **TSB2** (Pole Topper)
  - **WRB5**  
(Wrap Around Base)
  - **SF-1218**  
(Rectangle Sign Frame)
  - **TSB1**  
(Sign Mounting Brackets)
  - **Signs**  
- 12" W x 18" H  
Custom Sign

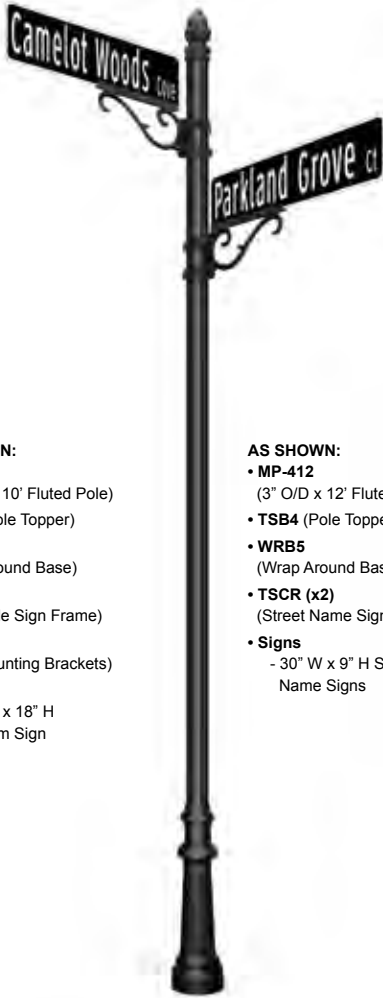

- AS SHOWN:**
- **MP-412**  
(3" O/D x 12' Fluted Pole)
  - **TSB4** (Pole Topper)
  - **WRB5**  
(Wrap Around Base)
  - **TSCR (x2)**  
(Street Name Sign Mounts)
  - **Signs**  
- 30" W x 9" H Street  
Name Signs

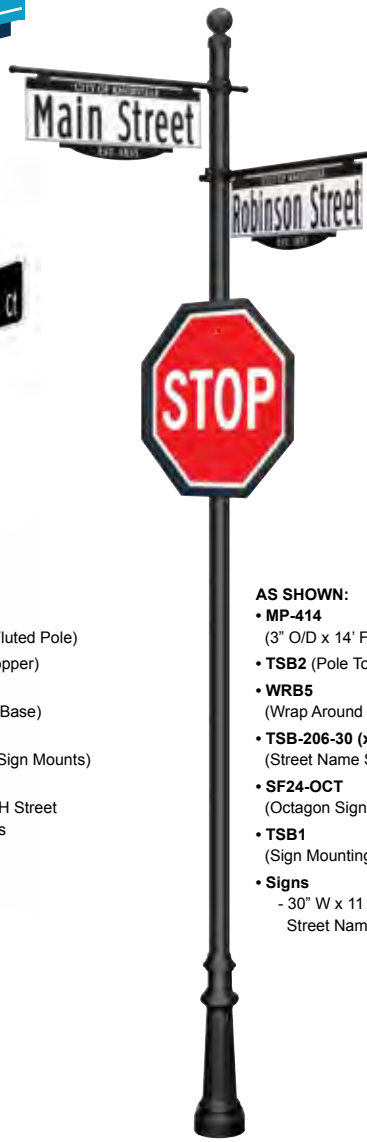

- AS SHOWN:**
- **MP-414**  
(3" O/D x 14' Fluted Pole)
  - **TSB2** (Pole Topper)
  - **WRB5**  
(Wrap Around Base)
  - **TSB-206-30 (x2)**  
(Street Name Sign Mounts)
  - **SF24-OCT**  
(Octagon Sign Frame)
  - **TSB1**  
(Sign Mounting Brackets)
  - **Signs**  
- 30" W x 11 1/2" H  
Street Name Signs

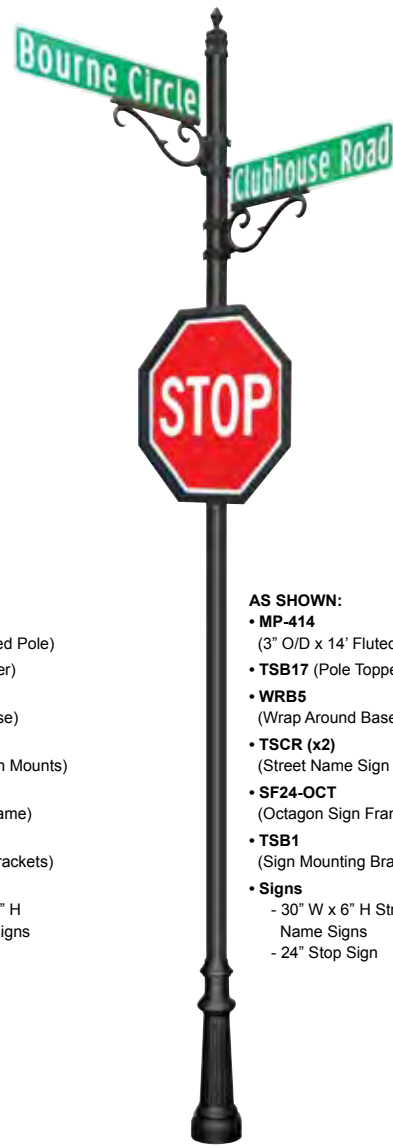

- AS SHOWN:**
- **MP-414**  
(3" O/D x 14' Fluted Pole)
  - **TSB17** (Pole Topper)
  - **WRB5**  
(Wrap Around Base)
  - **TSCR (x2)**  
(Street Name Sign Mounts)
  - **SF24-OCT**  
(Octagon Sign Frame)
  - **TSB1**  
(Sign Mounting Brackets)
  - **Signs**  
- 30" W x 6" H Street  
Name Signs  
- 24" Stop Sign





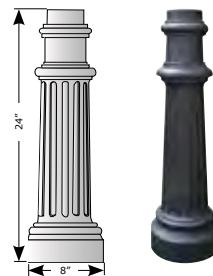

- 3" O/D round extruded aluminum poles
- Smooth and fluted aluminum poles with breakaway options available
- 24" Country Lane Series cast aluminum base
- See pages 10 - 15 for how to configure details and additional accessory options

### BASE DETAIL



### POLE OPTIONS

- 
**Smooth Breakaway**  
 • 3" O/D Round Pole  
 Approved by:  

- 
**Smooth**  
 • 3" O/D Round Pole
- 
**Fluted**  
 • 3" O/D Round Pole

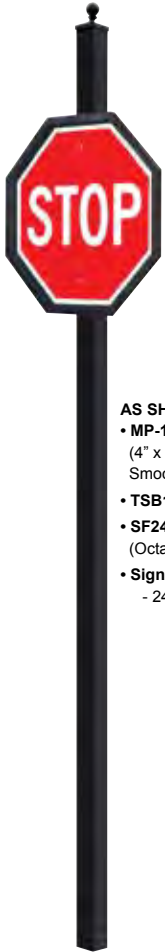

# SPRINGFIELD SERIES

## DECORATIVE TRAFFIC SIGNAGE



- AS SHOWN:**
- **MP-112**  
(4" x 4" x 12'  
Smooth Square Pole)
  - **TSB11** (Pole Topper)
  - **SF24-OCT**  
(Octagon Sign Frame)
  - **Signs**  
- 24" Stop Sign



- AS SHOWN:**
- **MP-112**  
(4" x 4" x 12'  
Smooth Square Pole)
  - **TSB12** (Pole Topper)
  - **Signs**  
- 18" W x 24" H Sign



- AS SHOWN:**
- **MP-114**  
(4" x 4" x 14'  
Smooth Square Pole)
  - **TSB11** (Pole Topper)
  - **WRB3**  
(Wrap Around Base)
  - **TSB-202-630 (x2)**  
(Street Name Sign Frames)
  - **Signs**  
- 30" W x 6" H Street  
Name Signs

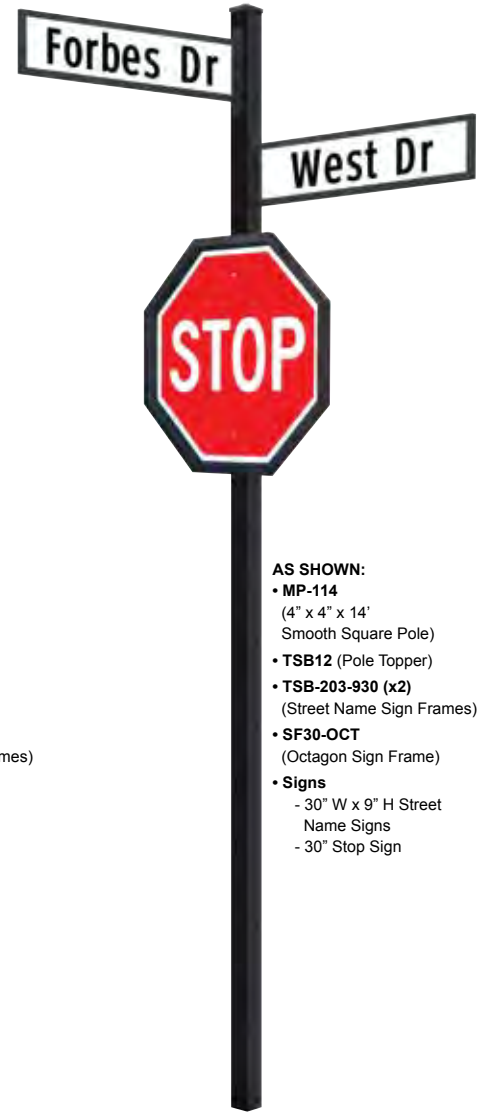

- AS SHOWN:**
- **MP-114**  
(4" x 4" x 14'  
Smooth Square Pole)
  - **TSB12** (Pole Topper)
  - **TSB-203-930 (x2)**  
(Street Name Sign Frames)
  - **SF30-OCT**  
(Octagon Sign Frame)
  - **Signs**  
- 30" W x 9" H Street  
Name Signs  
- 30" Stop Sign

- 4" x 4" smooth square extruded aluminum poles
- Poles available up to 16' lengths
- Optional decorative cast aluminum base
- See pages 10 - 15 for how to configure details and additional accessory options

### BASE DETAIL

Base is optional with this series.

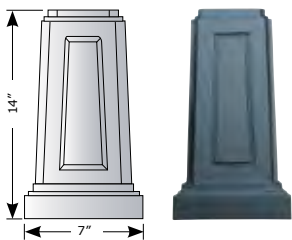

### POLE OPTIONS

**Smooth Square**  
4" x 4" Smooth Square



# HOW TO CONFIGURE YOUR SIGNAGE SYSTEM

Direct burial poles and accessories are made of extruded and cast aluminum. Direct burial poles require a minimum of 18" to 24" burial below grade in concrete for proper installation.

## STEP 1 - SELECT A POLE

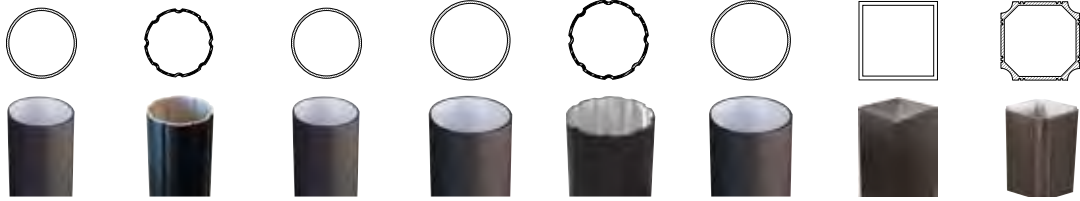

Length:	3" O/D Smooth	3" O/D Fluted	3" O/D Smooth Breakaway*	4" O/D Smooth	4" O/D Fluted	4" O/D Smooth Breakaway*	4" x 4" Smooth Square	4" x 4" Fluted Square
8' - 0"	SM-408	MP-408	BA-408	SM-608	MP-608	BA-608	MP-108	MP-708
10' - 0"	SM-410	MP-410	BA-410	SM-610	MP-610	BA-610	MP-110	MP-710
12' - 0"	SM-412	MP-412	BA-412	SM-612	MP-612	BA-612	MP-112	MP-712
14' - 0"	SM-414	MP-414	BA-414	SM-614	MP-614	BA-614	MP-114	N / A
16' - 0"	SM-416	MP-416	BA-416	SM-616	MP-616	BA-616	MP-116	N / A

\*meets U.S. Federal Highway Administration (FHWA) breakaway pole regulations.

## STEP 2 - SELECT A POLE TOPPER

### POLE TOPPERS FOR 3" O/D ROUND POLES



### POLE TOPPERS FOR 4" O/D ROUND POLES



### POLE TOPPERS FOR 4" x 4" SQUARE POLES

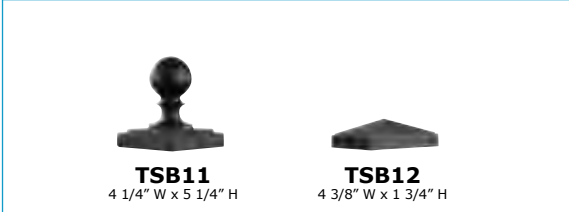

## STEP 3 - SELECT A BASE

### BASES FOR 3" O/D ROUND POLES



### BASES FOR 4" O/D ROUND POLES



### BASE FOR 4" SQUARE POLES



# HOW TO CONFIGURE YOUR SIGNAGE SYSTEM (CONTINUED)

## STEP 4 - SELECT STREET SIGN MOUNTS, BANNER ARMS OR CUSTOM SIGN MOUNTS

TSCR (Fits 3" O/D Pole)  
TSCR-600 (Fits 4" O/D Pole)

- Clamps around round pole
- Scroll: 16" W x 5 1/2" H



TSCR-700  
(Fits All Forsite Poles)

- Bolts to pole
- Scroll: 16" W x 5 1/2" H



TSCR-DBL (Fits 3" O/D Pole)  
TSCR-600-DBL (Fits 4" O/D Pole)

- Clamps around round pole
- Two TSCR brackets welded together at a 90° angle.
- Scrolls: 16" W x 5 1/2" H



TSB-201 (Fits 3" O/D Pole)  
TSB-601 (Fits 4" O/D Pole)

- Clamps around round pole
- Scroll: 16" W x 5 1/2" H
- Model # Example: **TSB-201-630** holds one 6" x 30" sign



TSB-201-DBL (Fits 3" O/D Pole)  
TSB-601-DBL (Fits 4" O/D Pole)

- Clamps around round pole
- Two TSB-201 or TSB-601 brackets welded together at a 90° angle.
- Scrolls: 16" W x 5 1/2" H



TSB-202  
(Fits All Forsite Poles)

- Bolts to pole
- Scroll: 16" W x 5 1/2" H
- Model # Example: **TSB-202-630** holds one 6" x 30" sign



TSB-203 (Street Name Sign Frame)  
TSB-203-99 (Logo Sign Frame)

- Bolts to pole
- Model # Example: Use **TSB-203-930** to order without Logo Sign Frame



TSB-205 (Fits 3" O/D Pole)  
TSB-605 (Fits 4" O/D Pole)

- Clamps around round pole
- Model # Example: **TSB-205-630** holds one 6" x 30" sign



TSB-205-DBL (Fits 3" O/D Pole)  
TSB-605-DBL (Fits 4" O/D Pole)

- Clamps around round pole
- Two TSB-205 or TSB-605 brackets welded together at a 90° angle.



TSB-206 (Fits 3" O/D Pole)  
TSB-606 (Fits 4" O/D Pole)

- Clamps around round pole
- Model # Example: **TSB-206-30** holds one 30" wide sign



TSB-207 (Fits 3" O/D Pole)  
TSB-607 (Fits 4" O/D Pole)

- Clamps around round pole
- Scroll: 16" W x 5 1/2" H
- Model # Example: **TSB-207-30** holds one 30" wide sign



TSB-208 (Fits 3" O/D Pole)  
TSB-608 (Fits 4" O/D Pole)

- Twist Lock Sign Mount
- 1" Diameter Hole Required in Pole



TSB-209 (Fits 3" O/D Pole)  
TSB-609 (Fits 4" O/D Pole)

- Twist Lock Sign Mount
- 1" Diameter Hole Required in Pole



TSB-210 (Fits 3" O/D Pole)  
TSB-610 (Fits 4" O/D Pole)

- Twist Lock Sign Mount
- 1" Diameter Hole Required in Pole



TSB-214 (Fits 3" O/D Pole)  
TSB-614 (Fits 4" O/D Pole)

- Clamps around round pole
- Model # Example: **TSB-214-18-Banner** holds up to a 18" wide banner
- Banner arms sold individually

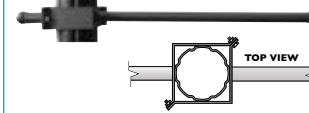

TSB-215  
(Fits All Forsite Poles)

- Bolts to pole
- 1/4" thick aluminum sign paddle
- Vinyl graphics applied to both sides of sign paddle



TSB-216  
(Fits All Forsite Poles)

- Bolts to pole
- 1/4" thick aluminum sign paddle
- Vinyl graphics applied to both sides of sign paddle



TSB-217 (Fits All Forsite Poles)  
Clamps around pole using stainless steel straps (fits up to a 12" diameter pole)

- Cast aluminum base and 3/4" Dia. white fiberglass arm
- Model # Example: **TSB-217-24** holds up to a 24" wide banner
- Banner arms sold individually
- Straps are not powder coated



The TSB series of Street Sign Mounts and Banner Arms can be ordered to hold a variety of sign sizes. Add the height and length of the sign blade in inches to the end of the item number of the desired sign.

- For example: A 6" x 24" sign blade in a TSB-201 bracket, the item number would be TSB-201-624.
- Length of the arm's bar will vary by the length of the sign blade. **Sign blades sold separately (except for TSB-215 and TSB-216).**

# HOW TO CONFIGURE YOUR SIGNAGE SYSTEM (CONTINUED)

## STEP 4 Continued - CUSTOM SIGN MOUNTS (OPTIONAL)

Custom Street Sign Mounts can be designed to give your community, commercial development or town a distinct and unique look. Choose from our custom examples below or send us your design plans and our creative team will develop the unique look that you desire. Plasma cut or vinyl logos can be added to almost any sign mount.

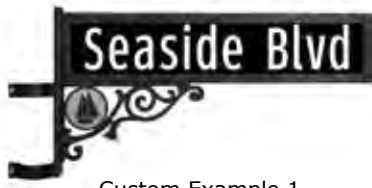

Custom Example 1

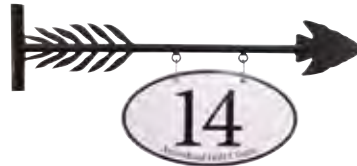

Custom Example 2



Custom Example 3



Custom Example 4



Custom Example 5



Custom Example 6



Custom Example 7



Custom Example 8



Custom Example 9

## STEP 5 - SELECT POLE TOP MOUNTS, FINIALS AND SIGN MOUNTING BRACKETS (OPTIONAL)

<p><b>TRO</b></p> <p>Fits 3" O/D round poles. Holds one .080 flat or extruded sign blade.</p> 	<p><b>DBL</b></p> <p>Fits on top of .080 flat or extruded street name sign. Holds one sign blade.</p> 	<p><b>TSB3</b></p> <p>Finial for flat or extruded street name signs. Dimensions: 1 3/4" W x 3 1/2" H</p> 	<p><b>TSB8</b></p> <p>Finial for flat or extruded street name signs. Dimensions: 1 7/8" W x 2 3/4" H</p> 	<p><b>TSB15</b></p> <p>4" to 3" pole adapter. Easily attach mounting brackets or a light fitter to a 4" O/D pole.</p> 
<p><b>TSB1 (Fits 3" O/D Pole)</b> <b>TSB61 (Fits 4" O/D Pole)</b></p> <p>Pole sign bracket / hardware (set of 2)</p> 	<p><b>TSB9 (Fits 3" O/D Pole)</b> <b>TSB62 (Fits 4" O/D Pole)</b></p> <p>Pole sign bracket / hardware for back to back signage mount (set of 2)</p> 	<p><b>TSB14 (Fits 3" O/D Pole)</b> <b>TSB63 (Fits 4" O/D Pole)</b></p> <p>Pole sign bracket / hardware (set of 2)</p>  <p>Mounting Example</p> 	<p><b>TSB13</b></p> <p>Vandal proof nuts (pack of 10)</p> 	<p>TSB1 brackets shown with BP24-OCT</p> 

# HOW TO CONFIGURE YOUR SIGNAGE SYSTEM (CONTINUED)

## STEP 6 - SELECT TRAFFIC SIGN BACK PLATES, SIGN TRIMS AND SIGN FRAMES (OPTIONAL)

### SIGN BACK PLATES

Back plates are made of .080 flat aluminum. Back plates provide a 1" wide flat edge on all sides of the sign. Measurements are for the sign blade going onto the back plate. Back plates are provided undrilled for custom mounting.

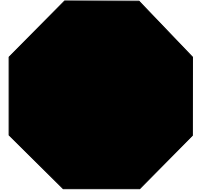

24" Back Plate BP24-OCT  
30" Back Plate BP30-OCT  
36" Back Plate BP36-OCT

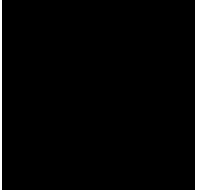

24" W x 24" H Back Plate BP-2424  
30" W x 30" H Back Plate BP-3030  
36" W x 36" H Back Plate BP-3636

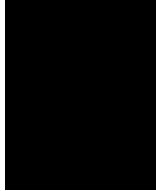

12" W x 18" H Back Plate BP-1218  
18" W x 24" H Back Plate BP-1824  
24" W x 30" H Back Plate BP-2430

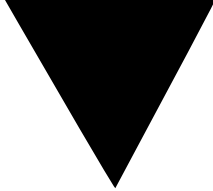

30" Back Plate BP30-TRI  
36" Back Plate BP36-TRI  
*measurement is point to point*



Back Plate Detail

### SIGN TRIMS

Measurements are for the sign blade fitting onto the sign trim. Sign Trims are pre-drilled for standard sign mounting.

*NOTE: Traffic Sign backs are standard "mill finish" and are visible through the backside of the open Sign Trim. For a small additional charge black vinyl can be applied to the back of the sign. Vinyl is not necessary when using Back Plates or Sign Frames.*

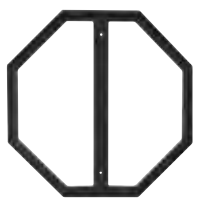

24" Sign Trim ST24-OCT  
30" Sign Trim ST30-OCT  
36" Sign Trim ST36-OCT



24" W x 24" H Sign Trim ST-2424  
30" W x 30" H Sign Trim ST-3030  
36" W x 36" H Sign Trim ST-3636



12" W x 18" H Sign Trim ST-1218  
18" W x 24" H Sign Trim ST-1824  
24" W x 30" H Sign Trim ST-2430

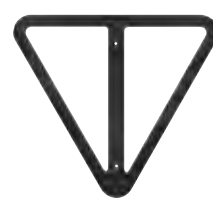

30" Sign Trim ST30-TRI  
36" Sign Trim ST36-TRI  
*measurement is point to point*



Sign Trim Detail

### SIGN FRAMES

Sign Frames are made with a .080 flat aluminum backing and a 1" x 1" square aluminum tubing to create a frame around the sign. Measurements are for the sign blade fitting into the sign frame. Sign frames are provided undrilled for custom mounting.



24" Sign Frame SF24-OCT  
30" Sign Frame SF30-OCT  
36" Sign Frame SF36-OCT



24" W x 24" H Sign Frame SF-2424  
30" W x 30" H Sign Frame SF-3030  
36" W x 36" H Sign Frame SF-3636



12" W x 18" H Sign Frame SF-1218  
18" W x 24" H Sign Frame SF-1824  
24" W x 30" H Sign Frame SF-2430



30" Sign Frame SF30-TRI  
36" Sign Frame SF36-TRI  
*measurement is point to point*



Sign Frame Detail

### CUSTOM BACK PLATES AND SIGN FRAMES

Add a custom design to your back plates or sign frames. Contact us today to learn more about creating a unique look for your community or commercial development.

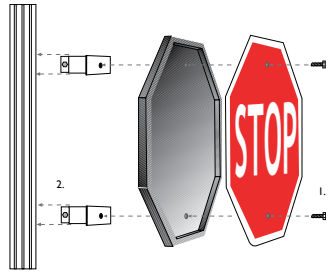

Back Plate, Sign Trim or Sign Frame mounting diagram (using TSB1 brackets)

# HOW TO CONFIGURE YOUR SIGNAGE SYSTEM (CONTINUED)

## STEP 7 - SELECT STREET NAME SIGN BLADES (OPTIONAL)

### STANDARD FLAT SIGN BLADE

6" High Blade  
by necessary length



9" High Blade  
by necessary length



### STANDARD EXTRUDED SIGN BLADE

6" High Blade  
by necessary length



9" High Blade  
by necessary length



### CUSTOM STREET NAME SIGN BLADE

We can customize any standard street sign to include your logo or create a plasma cut aluminum sign blade to make your street signs stand out from the rest. Choose from our custom examples below or send us your design plans and our creative team will develop the unique look that you desire.



**Custom Example 1**  
As Shown: 36" W x 6" H



**Custom Example 2**  
As Shown: 30" W x 10 3/8" H



**Custom Example 3**  
As Shown: 30" W x 10" H



**Custom Example 4**  
As Shown: 30" W x 9 3/4" H



**Custom Example 5**  
As Shown: 30" W x 15" H



**Custom Example 6**  
As Shown: 30" W x 16" H



**Custom Example 7**  
As Shown: 30" W x 10" H



**Custom Example 8**  
As Shown: 30" W x 11 1/2" H

## STEP 8 - SELECT MUTCD APPROVED SIGNAGE (OPTIONAL)

- Not limited to examples shown here, all standard MUTCD and custom signage options available
- Signage is available in Engineer Grade Prismatic, High Intensity Prismatic and Diamond Grade Prismatic Reflective Sheeting

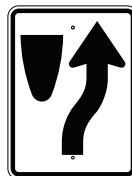

Street name and regulatory signs must conform to the Manual on Uniform Traffic Control Devices (MUTCD). Always check with your local ordinance or municipality to ensure size and reflectivity requirements are met or exceeded when purchasing traffic control signage.

# BREAKAWAY POLES

## BREAKAWAY POLES

Our 3" and 4" O/D smooth aluminum poles are approved by the U.S. Federal Highway Administration (FHWA) for breakaway pole regulations.

### NO SPECIAL ADAPTER OR OTHER DEVICE IS REQUIRED.

Our breakaway poles are omni directional, meaning they don't require poles to face a certain direction and can easily be installed in any orientation.

#### Ordering Example:

**BA-4\*\*** (3" O/D breakaway pole)

**BA-6\*\*** (4" O/D breakaway pole)

\*\* = length of pole (ex: BA-410 = 3" O/D x 10 ft. length)

Poles are available in 8 ft., 10 ft., 12 ft., 14 ft., and 16 ft. lengths



3" O/D  
Breakaway\*

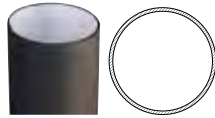

4" O/D  
Breakaway\*

\*meets U.S. Federal Highway Administration (FHWA) breakaway pole regulations.

## BREAKAWAY POLES APPROVED BY THE:

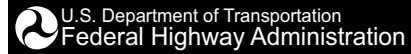

## BREAKAWAY POLE KIT

For use with any 3" O/D non-breakaway pole.

By using the patented breakaway pole kit, any 3" O/D pole can be U.S. Federal Highway Administration breakaway compliant.

Flush-to-the-ground configuration allows sign poles to breakaway or release cleanly at ground level, with a 360 degree impact zone.

Once the break away pole kit is installed, you simply insert the pole and drive in the wedge, locking the post into the anchor without the need of any additional hardware.

#### Item Number:

**VR3** - (Breakaway pole kit for 3" O/D poles)



WAYFINDING AND  
ENTRANCE SIGNS





# WAYFINDING AND ENTRANCE SIGN SYSTEMS



Example 1A



Example 1B



Example 1C



Example 1D

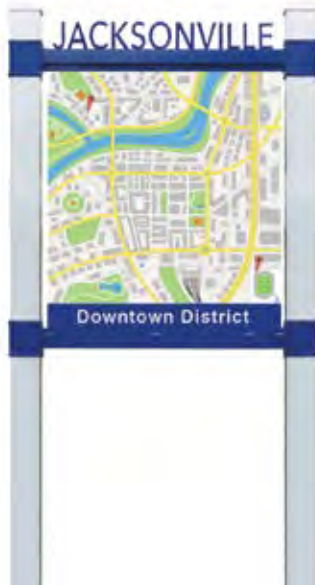

Example 2A



Example 2B



Example 2C



Example 2D

# WAYFINDING AND ENTRANCE SIGN SYSTEMS (CONTINUED)



Example 3



Example 4



Example 5



Example 6



Example 7



Example 8

# WAYFINDING AND ENTRANCE SIGNS



Example 9



Example 10



Example 11



Example 12



Example 13



Example 14



# CURBSIDE MAILBOX SYSTEMS



# ASHLEY

CURBSIDE MAILBOX SYSTEM

Add a contemporary look to your curb appeal with our Ashley curbside mailbox system.

Our mailbox systems are constructed of rust free aluminum and powder coated using any of our durable finish options.

Mounting Arm Shown:  
Ashley Front Single Mounting Arm  
(Topper and Post selected separately)



Complete your  
**ASHLEY MAILBOX SYSTEM**  
by selecting your post, post topper,  
mailbox, base & additional accessories  
on page 33.

### HOW TO ORDER EXAMPLE:

Ashley-FS - 3SM - 2 - 1017 - 5 - BLK  
Bracket Post Topper Mailbox Base Finish  
Option

### Ashley Mailbox System Examples:

Choose from 3 mounting options and complete your mailbox system with accessories on page 33.

#### FRONT SINGLE (FS)

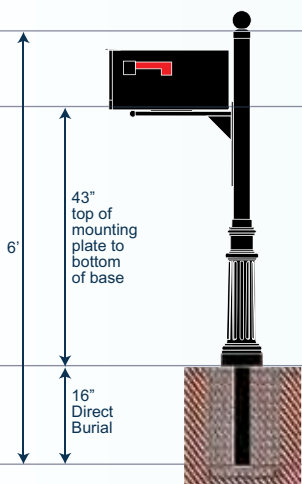

MODEL NUMBER FOR EXAMPLE SHOWN  
**Ashley-FS-3SM-2-1018A-5**

#### SIDE SINGLE (SS)

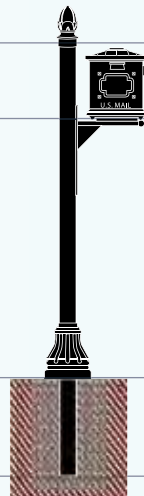

MODEL NUMBER FOR EXAMPLE SHOWN  
**Ashley-SS-3SM-4-1017-8**

#### SIDE DOUBLE (SDBL)

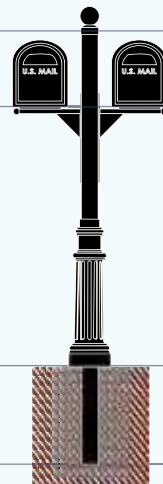

MODEL NUMBER FOR EXAMPLE SHOWN  
**Ashley-SDBL-3SM-2-1008-5**

# ATLANTIC

CURBSIDE MAILBOX SYSTEM

Classic styling best describes this popular curbside mailbox system with its decorative mounting arm and large address plaque.

Our mailbox systems are constructed of rust free aluminum and powder coated using any of our durable finish options.

Mounting Arm Shown:  
Atlantic Front Single Mounting Arm  
(Topper, Post and Numbers selected separately)

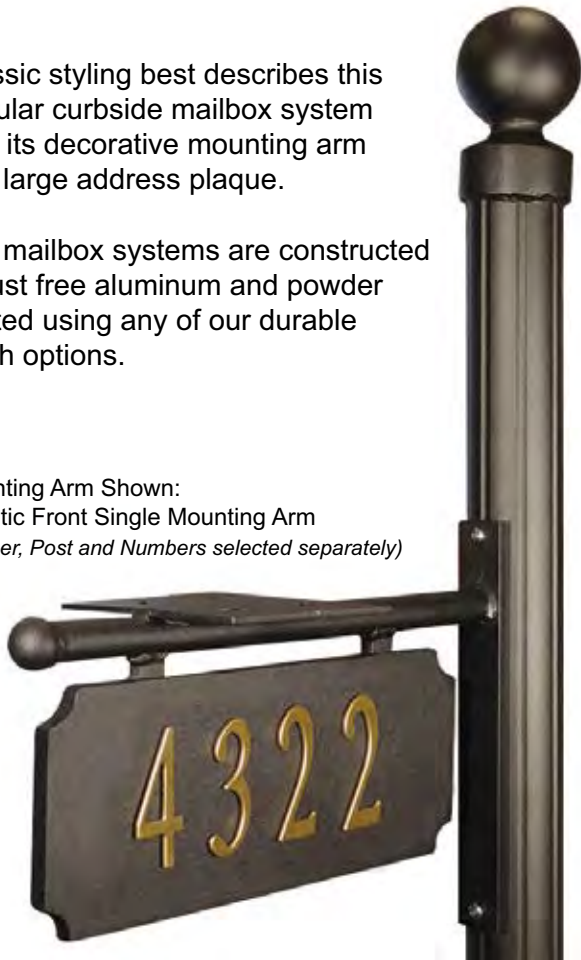

Complete your  
**ATLANTIC MAILBOX SYSTEM**  
by selecting your post, post topper,  
mailbox, base & additional accessories  
on page 33.

### HOW TO ORDER EXAMPLE:

Atlantic-FS - 3SM - 2 - 1017 - 5 - BLK  
Bracket Post Topper Mailbox Base Finish  
Option

### Atlantic Mailbox System Examples:

Choose from 3 mounting options and complete your mailbox system with accessories on page 33.

#### FRONT SINGLE (FS)

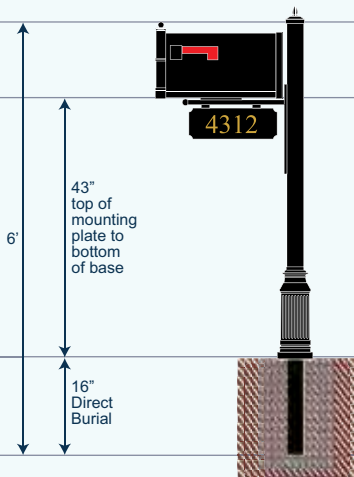

MODEL NUMBER FOR EXAMPLE SHOWN  
Atlantic-FS-3SM-21-1015-17

#### SIDE SINGLE (SS)

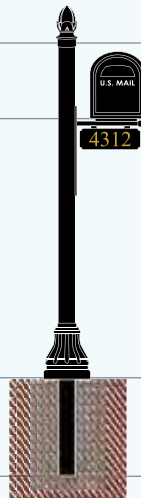

MODEL NUMBER FOR EXAMPLE SHOWN  
Atlantic-SS-3SM-4-1008-8

#### SIDE DOUBLE (SDBL)

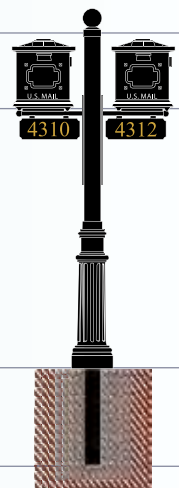

MODEL NUMBER FOR EXAMPLE SHOWN  
Atlantic-SDBL-3SM-2-1017-5

# AUSTIN

CURBSIDE MAILBOX SYSTEM

The traditional style and design of the Austin curbside mailbox system will provide a beautiful addition to a home's curb appeal.

Our mailbox systems are constructed of rust free aluminum and powder coated using any of our durable finish options.

Mounting Arm Shown:  
Austin Front Single Mounting Arm  
(Topper, Post and Numbers selected separately)

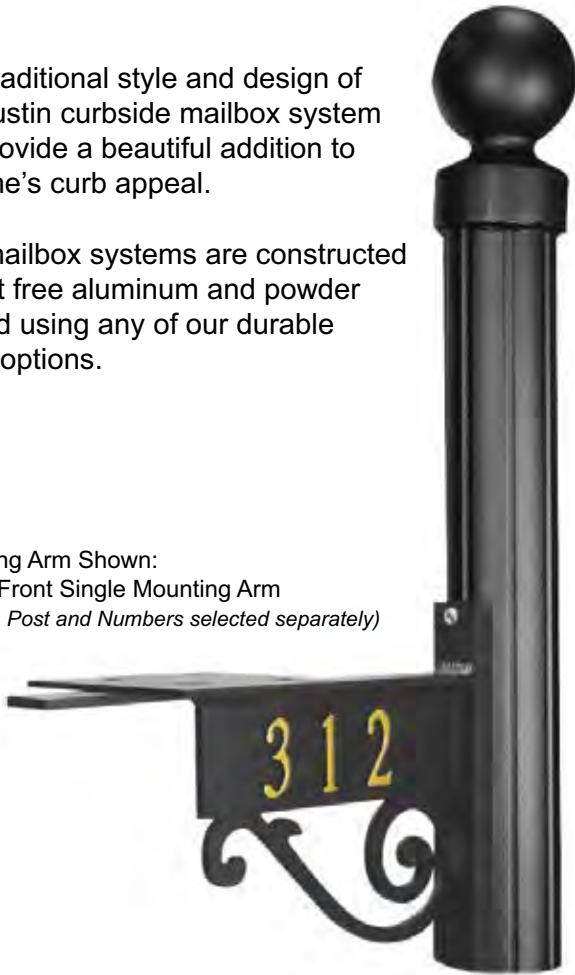

Complete your  
**AUSTIN MAILBOX SYSTEM**  
by selecting your post, post topper,  
mailbox, base & additional accessories  
on page 33.

### HOW TO ORDER EXAMPLE:

Austin-FS - 3SM - 2 - 1017 - 5 - BLK  
Bracket - Post - Topper - Mailbox - Base - Finish  
Option

### Austin Mailbox System Examples:

Choose from 3 mounting options and complete your mailbox system with accessories on page 33.

#### FRONT SINGLE (FS)

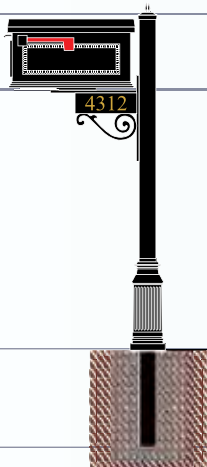

MODEL NUMBER FOR EXAMPLE SHOWN  
Austin-FS-3SM-21-1010-17

#### SIDE SINGLE (SS)



MODEL NUMBER FOR EXAMPLE SHOWN  
Austin-SS-3SM-2-1017-8

#### SIDE DOUBLE (SDBL)

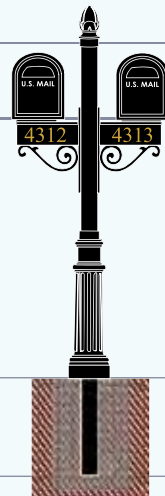

MODEL NUMBER FOR EXAMPLE SHOWN  
Austin-SDBL-3SM-4-1008-5

# BEL-AIRE

CURBSIDE MAILBOX SYSTEM

The decorative scroll work of the Bel-Aire provides a sophisticated look to your mailbox unit. This style is also available with an optional address plaque. (Estate Series)

Our mailbox systems are constructed of rust free aluminum and powder coated using any of our durable finish options.

Mounting Arm Shown:  
Bel-Aire Front Single Mounting Arm  
(Topper and Post selected separately)

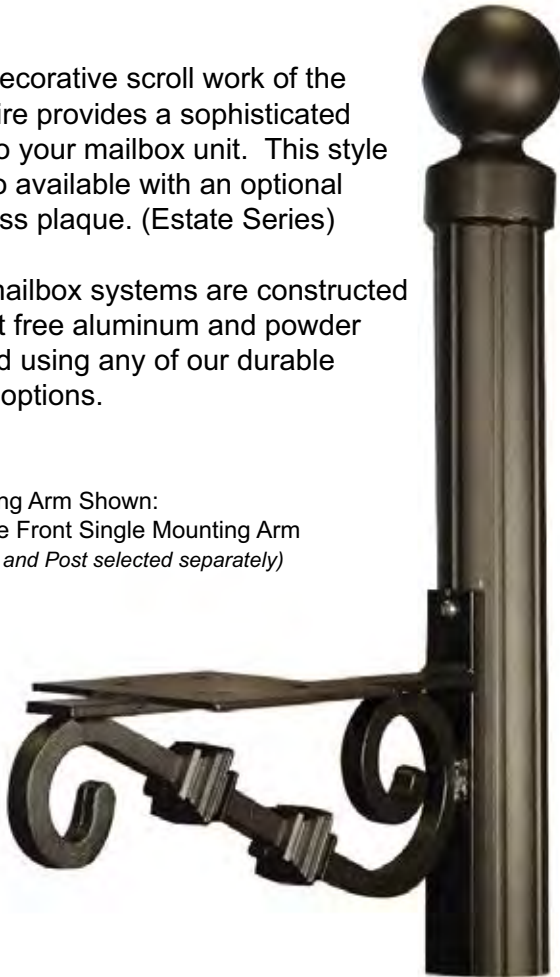

Product Shown:  
Bel-Aire-FS-3FL-2-1010-5-MP453

Complete your  
**BEL-AIRE MAILBOX SYSTEM**  
by selecting your post, post topper,  
mailbox, base & additional accessories  
on page 33.

### HOW TO ORDER EXAMPLE:

Bel-Aire-FS - 3SM - 2 - 1017 - 5 - BLK  
Bracket Post Topper Mailbox Base Finish  
Option

### Bel-Aire Mailbox System Examples:

Choose from 4 mounting options and complete your mailbox system with accessories on page 33.

#### FRONT SINGLE (FS)

#### FRONT DOUBLE (FDBL)

#### SIDE SINGLE (SS)

#### SIDE DOUBLE (SDBL)

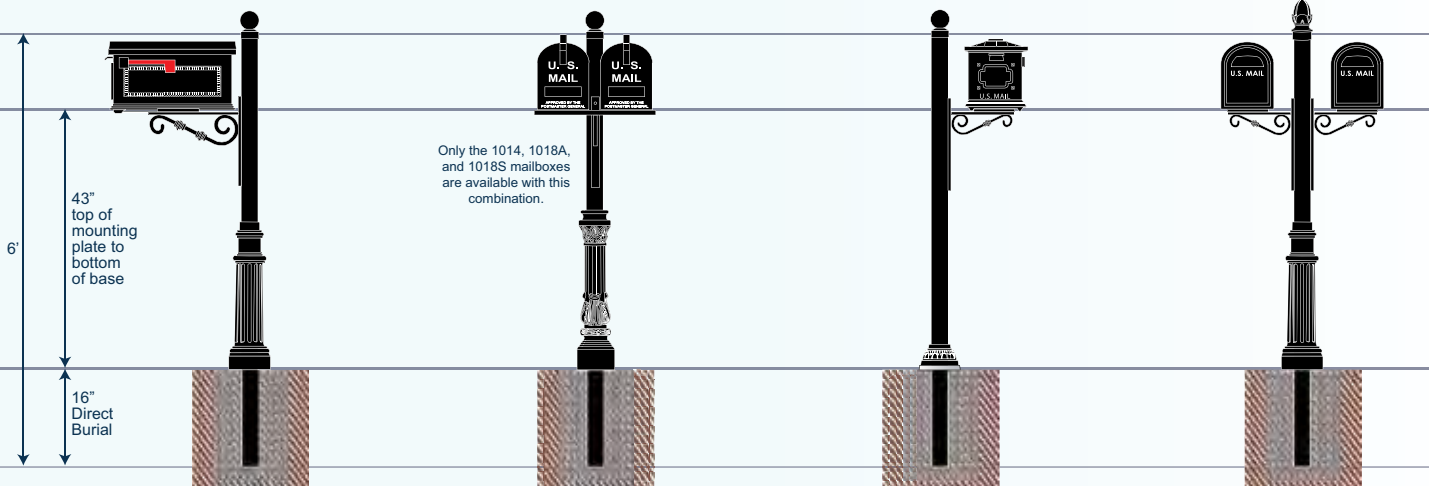

MODEL NUMBER FOR EXAMPLE SHOWN  
Bel-Aire-FS-3SM-2-1010-5

MODEL NUMBER FOR EXAMPLE SHOWN  
Bel-Aire-FDBL-3SM-2-1018-2

MODEL NUMBER FOR EXAMPLE SHOWN  
Bel-Aire-SS-3SM-2-1017-7

MODEL NUMBER FOR EXAMPLE SHOWN  
Bel-Aire-SDBL-3SM-4-1008-5



# BRADFORD

CURBSIDE MAILBOX SYSTEM



The Bradford curbside mailbox system is a simple, yet attractive top mount post system.

Mounting Arm Shown:  
Bradford Top Mount Bracket  
with a 1010 Traditional mailbox.  
(Post and Mailbox selected separately)



Product Shown:  
Bradford-TS-3FL-1017

Complete your  
**BRADFORD MAILBOX SYSTEM**  
by selecting your post, mailbox,  
base & additional accessories  
on page 33.

### HOW TO ORDER EXAMPLE:

Bradford-TS - 3SM - 1017 - 5 - BLK  
*Bracket Post Mailbox Base Finish*  
*Option*

### Bradford Mailbox System Examples:

Choose from 2 mounting options and complete your mailbox system with accessories on page 33.

#### TOP SINGLE (TS)

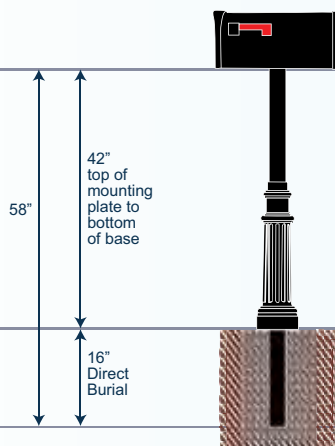

MODEL NUMBER FOR EXAMPLE SHOWN  
Bradford-TS-3SM-1008-5

#### TOP DOUBLE (TDBL)

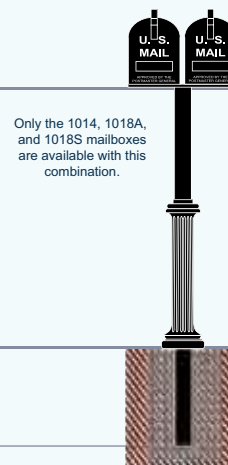

MODEL NUMBER FOR EXAMPLE SHOWN  
Bradford-TDBL-3SM-1018A-1

# HEMPFIELD

CURBSIDE MAILBOX SYSTEM

Answering the desire for luxurious suburban living, the Hempfield curbside mailbox system offers beautiful results in our entire array of finishes.

Our mailbox systems are constructed of rust free aluminum and powder coated using any of our durable finish options.

Mounting Arm Shown:  
Hempfield Front Single Mounting Arm  
(Topper and Post selected separately)

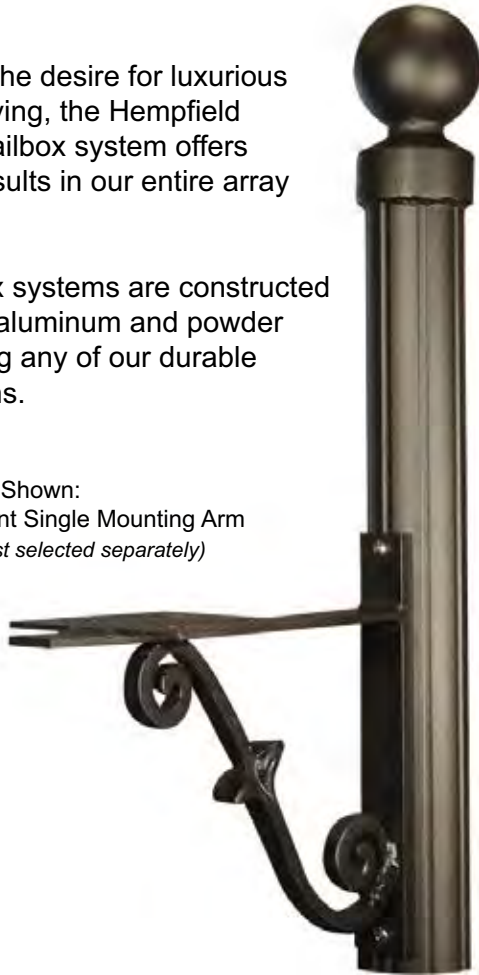

Product Shown:  
Hempfield-FS-4SQ-11-1017 with MP-455

Complete your  
**HEMPFIELD MAILBOX SYSTEM**  
by selecting your post, post topper,  
mailbox, base & additional accessories  
on page 33.

### HOW TO ORDER EXAMPLE:

Hempfield-FS - 3SM - 2 - 1017 - 5 - BLK  
*Bracket Post Topper Mailbox Base Finish*  
*Option*

### Hempfield Mailbox System Examples:

Choose from 2 mounting options and complete your mailbox system with accessories on page 33.

#### FRONT SINGLE (FS)

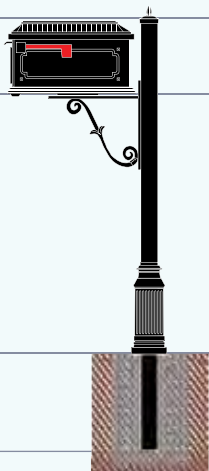
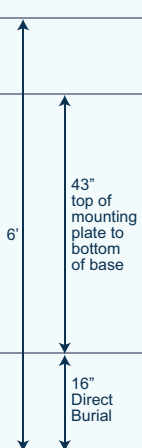

MODEL NUMBER FOR EXAMPLE SHOWN  
Hempfield-FS-3SM-21-1017-17

#### FRONT DOUBLE (FDBL)

Only the 1014, 1018A,  
and 1018S mailboxes  
are available with this  
combination.

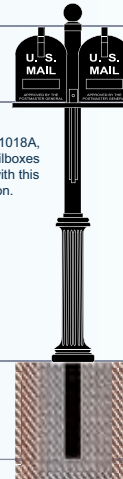

MODEL NUMBER FOR EXAMPLE SHOWN  
Hempfield-FDBL-3SM-2-1018A-1

# PACIFIC

CURBSIDE MAILBOX SYSTEM

Classic styling best describes the Pacific mailbox system with its decorative mounting arm and a large address plaque with rounded edge design.

Our mailbox systems are constructed of rust free aluminum and powder coated using any of our durable finish options.

Mounting Arm Shown:  
Pacific Front Single Mounting Arm  
(Topper, Post and Numbers selected separately)



Product Shown:  
Pacific-FS-3SM-4-1017

Complete your  
**PACIFIC MAILBOX SYSTEM**  
by selecting your post, post topper,  
mailbox, base & additional accessories  
on page 33.

### HOW TO ORDER EXAMPLE:

Pacific-FS - 3SM - 2 - 1017 - 5 - BLK  
*Bracket Post Topper Mailbox Base Finish*  
*Option*

### Pacific Mailbox System Examples:

Choose from 3 mounting options and complete your mailbox system with accessories on page 33.

#### FRONT SINGLE (FS)

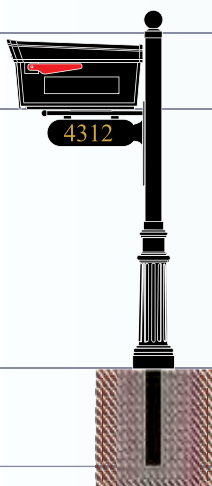

MODEL NUMBER FOR EXAMPLE SHOWN  
Pacific-FS-3SM-2-1007-5

#### SIDE SINGLE (SS)



MODEL NUMBER FOR EXAMPLE SHOWN  
Pacific-SS-3SM-4-1008-8

#### SIDE DOUBLE (SDBL)

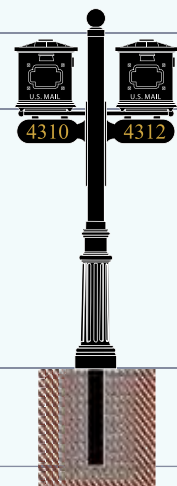

MODEL NUMBER FOR EXAMPLE SHOWN  
Pacific-SDBL-3SM-2-1017-5

# PALMS

CURBSIDE MAILBOX SYSTEM

The Palms curbside mailbox system includes an easy to attach decorative palm tree bracket that will provide a unique look to a home's curb appeal.

Our mailbox systems are constructed of rust free aluminum and powder coated using any of our durable finish options.



Mounting Arm Shown:  
Palms Front Single Mounting Arm  
(*Topper, Post and Numbers selected separately*)



Product Shown:  
Palms-FS-3FL-2-1017-1

Complete your  
**PALMS MAILBOX SYSTEM**  
by selecting your post, post topper,  
mailbox, base & additional accessories  
on page 33.

### HOW TO ORDER EXAMPLE:

Palms-FS - 3SM - 2 - 1017 - 5 - BLK  
*Bracket Post Topper Mailbox Base Finish*  
*Option*

### Palms Mailbox System Examples:

Choose from 4 mounting options and complete your mailbox system with accessories on page 33.

#### FRONT SINGLE (FS)

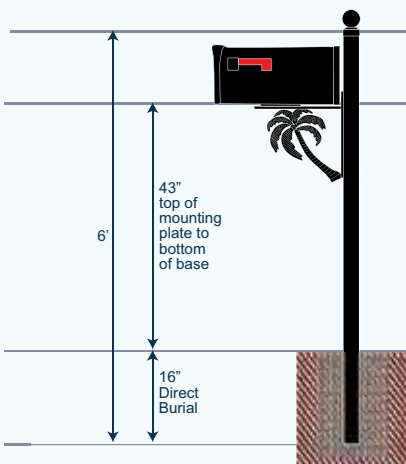

MODEL NUMBER FOR EXAMPLE SHOWN  
Palms-FS-3SM-2-1008

#### FRONT DOUBLE (FDBL)

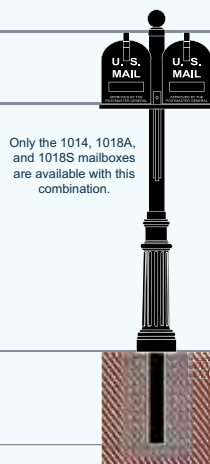

MODEL NUMBER FOR EXAMPLE SHOWN  
Palms-FDBL-3SM-2-1018-5

#### SIDE SINGLE (SS)

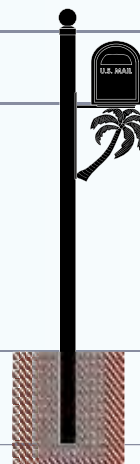

MODEL NUMBER FOR EXAMPLE SHOWN  
Palms-SS-3SM-2-1008

#### SIDE DOUBLE (SDBL)

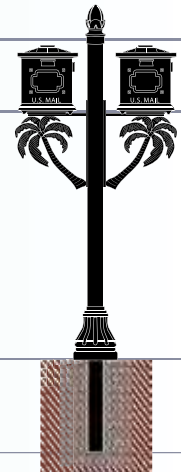

MODEL NUMBER FOR EXAMPLE SHOWN  
Palms-SDBL-3SM-4-1017-8

# SEASIDE

CURBSIDE MAILBOX SYSTEM

The Seaside curbside mailbox system includes a simple, yet decorative scroll design.

Our mailbox systems are constructed of rust free aluminum and powder coated using any of our durable finish options.

Mounting Arm Shown:  
Seaside Front Single Mounting Arm  
(Topper and Post selected separately)

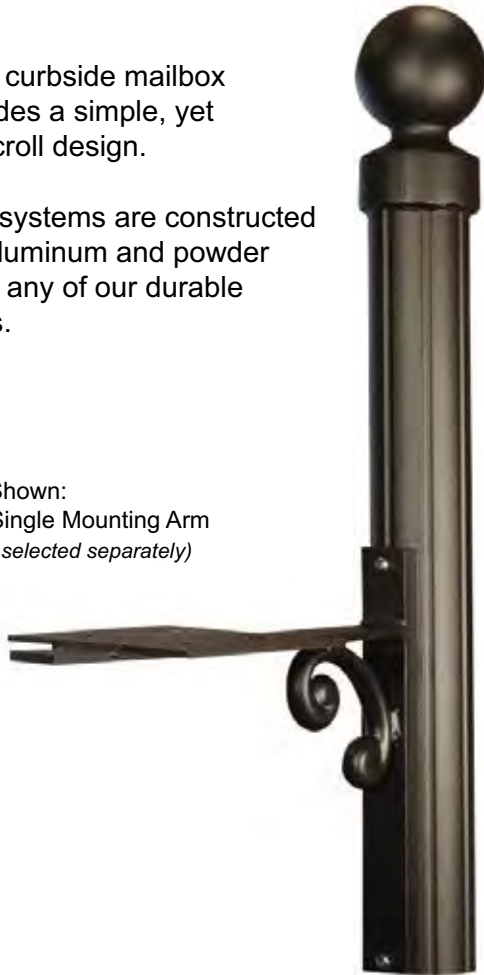

Complete your  
**SEASIDE MAILBOX SYSTEM**  
by selecting your post, post topper,  
mailbox, base & additional accessories  
on pages 33.

### HOW TO ORDER EXAMPLE:

Seaside-FS - 3SM - 2 - 1017 - 5 - BLK  
*Bracket Post Topper Mailbox Base Finish*  
*Option*

### Seaside Mailbox System Examples:

Choose from 4 mounting options and complete your mailbox system with accessories on page 33.

#### FRONT SINGLE (FS)

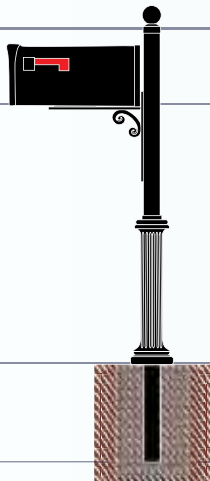

MODEL NUMBER FOR EXAMPLE SHOWN  
Seaside-FS-3SM-2-1008-1

#### FRONT DOUBLE (FDBL)



MODEL NUMBER FOR EXAMPLE SHOWN  
Seaside-FDBL-3SM-2-1018A-2

Only the 1014, 1018A, and 1018S mailboxes are available with this combination.

#### SIDE SINGLE (SS)

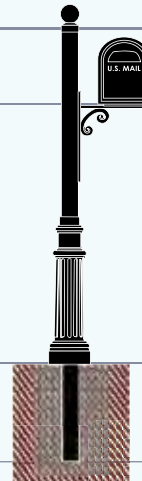

MODEL NUMBER FOR EXAMPLE SHOWN  
Seaside-SS-3SM-2-1008-5

#### SIDE DOUBLE (SDBL)

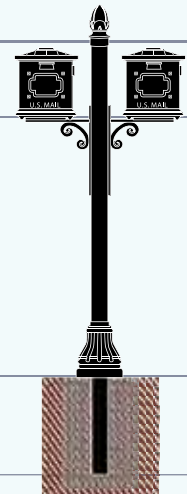

MODEL NUMBER FOR EXAMPLE SHOWN  
Seaside-SDBL-3SM-4-1017-8

# SINCLAIR

CURBSIDE MAILBOX SYSTEM

The Sinclair curbside mailbox system has a deeply embossed, elegant scroll arm.

Our mailbox systems are constructed of rust free aluminum and powder coated using any of our durable finish options.

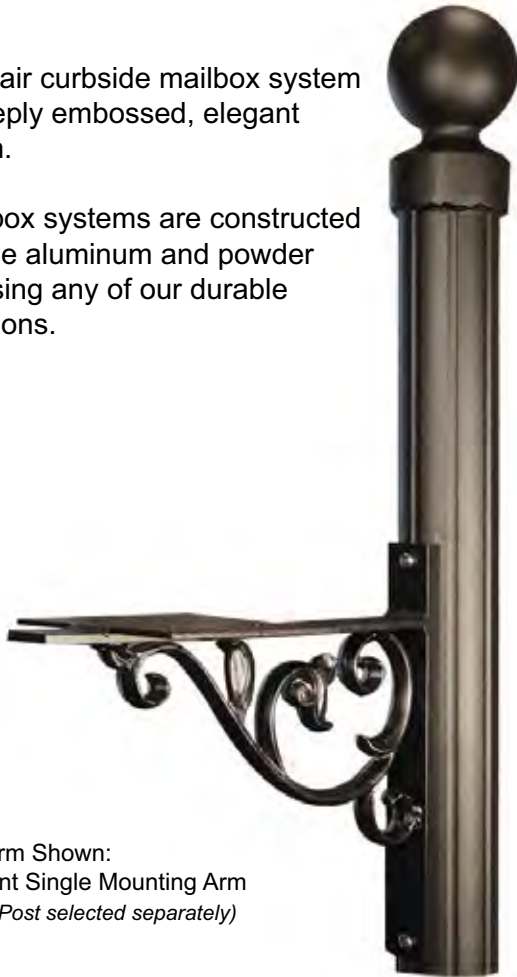

Mounting Arm Shown:  
Sinclair Front Single Mounting Arm  
(Topper and Post selected separately)



Product Shown:  
Sinclair-FS-3FL-2-1010-1

Complete your  
**SINCLAIR MAILBOX SYSTEM**  
by selecting your post, post topper,  
mailbox, base & additional accessories  
on page 33.

### HOW TO ORDER EXAMPLE:

Sinclair-FS - 3SM - 2 - 1017 - 5 - BLK  
Bracket Post Topper Mailbox Base Finish  
Option

### Sinclair Mailbox System Examples:

Choose from 4 mounting options and complete your mailbox system with accessories on page 33.

#### FRONT SINGLE (FS)

#### FRONT DOUBLE (FDBL)

#### SIDE SINGLE (SS)

#### SIDE DOUBLE (SDBL)

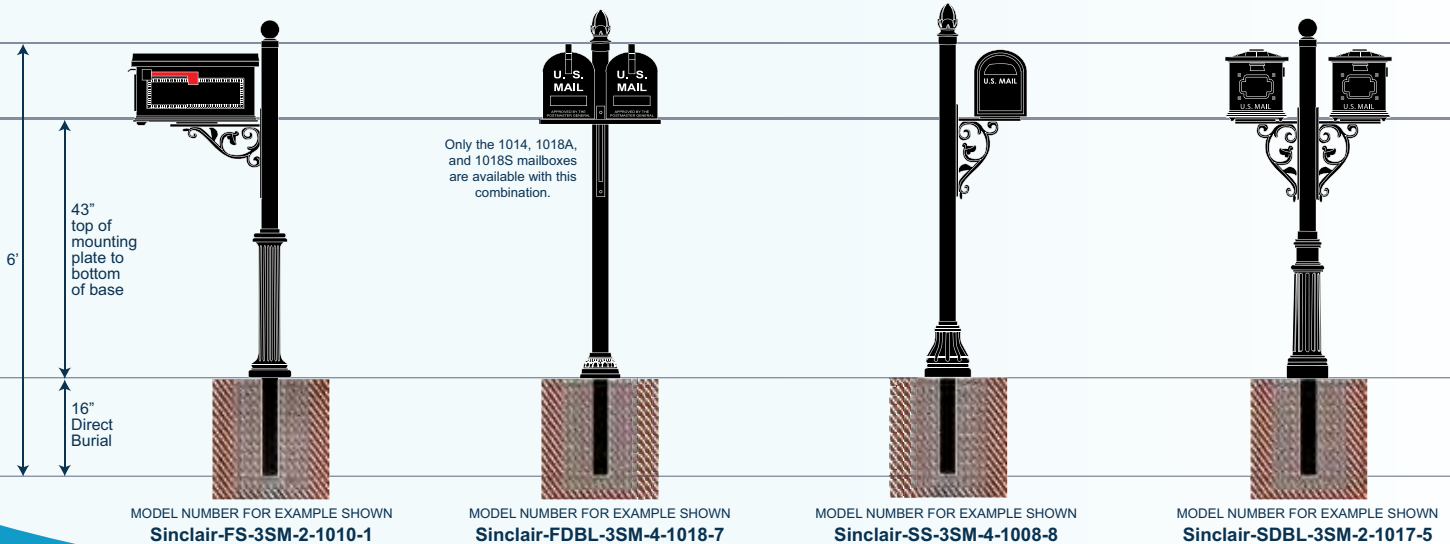

# SORRENTO

CURBSIDE MAILBOX SYSTEM

The elegant scroll arm of the Sorrento curbside mailbox system will provide a high class, decorative look to any home.

Our mailbox systems are constructed of rust free aluminum and powder coated using any of our durable finish options.

Mounting Arm Shown:  
Sorrento Front Single Mounting Arm  
(Topper and Post selected separately)

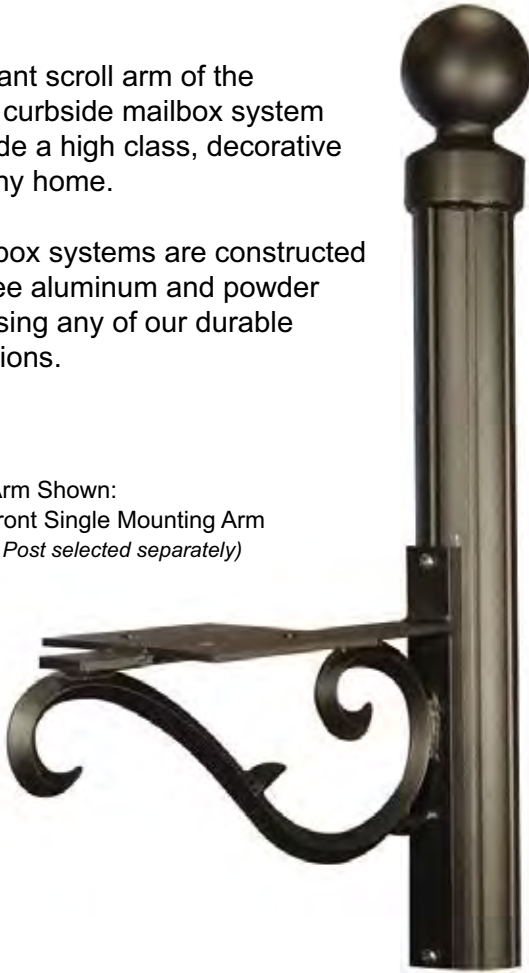

Complete your  
**SORRENTO MAILBOX SYSTEM**  
by selecting your post, post topper,  
mailbox, base & additional accessories  
on page 33.

**HOW TO ORDER EXAMPLE:**  
Sorrento-FS - 3SM - 2 - 1017 - 5 - BLK  
*Bracket Post Topper Mailbox Base Finish*  
*Option*

**Sorrento Mailbox System Examples:**  
Choose from 4 mounting options and complete your mailbox system with accessories on page 33.

**FRONT SINGLE (FS)**



MODEL NUMBER FOR EXAMPLE SHOWN  
Sorrento-FS-3SM-2-1015-5

**FRONT DOUBLE (FDBL)**



MODEL NUMBER FOR EXAMPLE SHOWN  
Sorrento-FDBL-3SM-5-1018-2

**SIDE SINGLE (SS)**

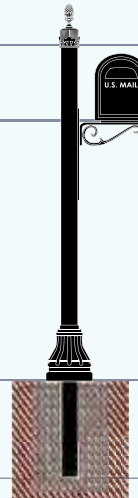

MODEL NUMBER FOR EXAMPLE SHOWN  
Sorrento-SS-3SM-17-1008-8

**SIDE DOUBLE (SDBL)**

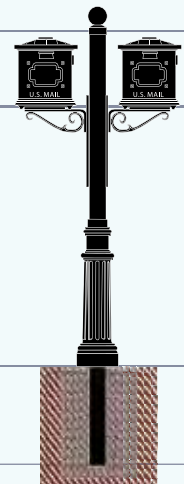

MODEL NUMBER FOR EXAMPLE SHOWN  
Sorrento-SDBL-3SM-2-1017-5

# WINGATE

CURBSIDE MAILBOX SYSTEM

The contemporary design of the Wingate curbside mailbox system will provide an upscale look to any home.

Our mailbox systems are constructed of rust free aluminum and powder coated using any of our durable finish options.



Mounting Arm Shown:  
Wingate Front Single Mounting Arm  
(Topper and Post selected separately)



Product Shown:  
Wingate-FS-3FL-2-1014-1

Complete your  
**WINGATE MAILBOX SYSTEM**  
by selecting your post, post topper,  
mailbox, base & additional accessories  
on page 33.

### HOW TO ORDER EXAMPLE:

Wingate-FS - 3SM - 2 - 1017 - 5 - BLK  
Bracket    Post    Topper    Mailbox    Base    Finish  
Option

### Wingate Mailbox System Examples:

Choose from 2 mounting options and complete your mailbox system with accessories on page 33.

#### FRONT SINGLE (FS)

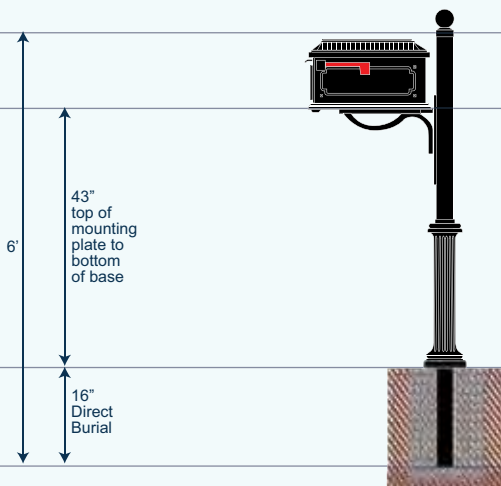

MODEL NUMBER FOR EXAMPLE SHOWN  
Wingate-FS-3SM-2-1017-1

#### FRONT DOUBLE (FDBL)

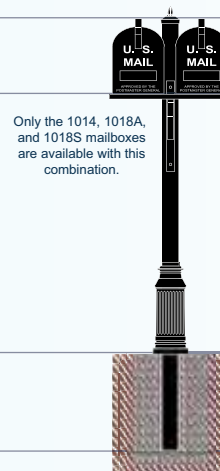

MODEL NUMBER FOR EXAMPLE SHOWN  
Wingate-FDBL-3SM-21-1018-17



# HOW TO CONFIGURE YOUR MAILBOX SYSTEM

## How to Configure Example:

Atlantic-FS - 3FL - 2 - 1017 - 5 - BLK  
*Bracket Post Topper Mailbox Base Finish*

STEP 1

### Select a Mounting Bracket:

Choose a mounting bracket style from pages 21 - 32. (Example: Sinclair)  
 Additional standard and custom mounting brackets are available. Please contact Forsite for details.

STEP 2

### Select a Post:

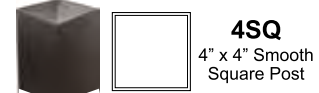

STEP 3

### Select a Post Topper:

(For 3" Round Posts Only)



(For 4" Square Posts Only)

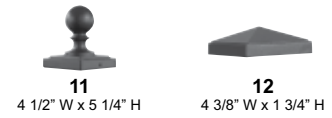

STEP 4

### Select a Mailbox:



All of our mailboxes and components shown here are made of high quality cast or extruded aluminum (except for 1018S) and can be personalized to meet your needs. Newspaper tubes are an available option.

STEP 5

### Select a Base:

(For 3" Round Posts Only)



(For 4" Square Posts Only)



STEP 6

### Select a Finish:



STEP 7

### Select Address Numbers:

Available in your choice of self adhesive stainless steel, polished brass or reflective vinyl. 2" and 3" tall number sizes available. Durable and easy to apply.



#### Model Numbers:

- VN2 - 2" Reflective Vinyl Numbers (White or Gold)
- VN3 - 3" Reflective Vinyl Numbers (White or Gold)
- SS2 - 2" Stainless Steel Numbers
- BR2 - 2" Polished Brass Numbers
- SS3 - 3" Stainless Steel Numbers
- BR3 - 3" Polished Brass Numbers

# CURBSIDE MAILBOXES, POSTS, AND WALL MOUNT MAILBOXES

AUTHORIZED DISTRIBUTOR OF



- Cast and extruded aluminum construction
- Durable powder coated finish

## Curbside Mailbox Posts



SPK-600

SPK-600-DBL

SPK-651

450

SMP-550

SPK-591

## Curbside Mailboxes



SCF-1003



SCB-1005



SCB-1005-NAT

*Additional curbside mailbox styles are available.*

## Wall Mount Mailboxes - Newspaper scrolls provided with all wall mount mailboxes



SHF-1001

SHC-1002

SHB-1004

SHB-1004-NAT

SHH-1006

SVC-1002

SVF-1001

## Multi-Unit Mailbox System Examples



# CURBSIDE MAILBOXES AND POSTS

AUTHORIZED DISTRIBUTOR OF



- Cast and extruded aluminum construction
- Durable powder coated finish

## Curbside Mailbox Posts



## Curbside Mailboxes



## Mailbox Post Accessories



## Address Plaques



# CLUSTER BOX UNITS

AUTHORIZED DISTRIBUTOR OF

# FLORENCE CORPORATION

## Cluster Box Units

The most popular centralized mail delivery equipment for residential neighborhoods is the free-standing, pedestal-mounted Cluster Box Unit (CBU). Whether your neighborhood has aging mailboxes or your municipality is requiring you to switch to a centralized mail location, secure and convenient cluster box units may be the solution.



**1570-8**  
- 8 Tenant Doors  
- 2 Parcel Lockers



**1570-12**  
- 12 Tenant Doors  
- 1 Parcel Locker



**1570-13**  
- 13 Tenant Doors  
- 1 Parcel Locker



**1570-16**  
- 16 Tenant Doors  
- 2 Parcel Lockers

*All cluster box units are available in multiple color options, all in a durable powder coated finish.*



Looking for a way to turn your standard CBU into something more "upscale"? Forsite has many attractive accessories available.



## 4C MAILBOX SYSTEMS AND SITE FURNISHINGS

### Versatile 4C Mailboxes

4C mailboxes provide a simple, easy to use 'pre-configured' line of mailboxes and parcel lockers which meet or exceed every security requirement of the USPS. Multiple configurations and applications are available.



### Site Furnishings

Decorative site furnishing products are used to beautify public spaces and enhance outdoor environments.

- Weather resistant powder coated finish that resists scratching
- Additional product options are available, contact us today for more details



Benches

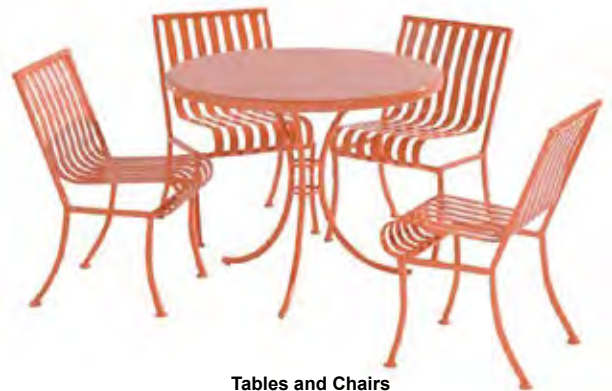

Tables and Chairs



Waste Receptacles



Bike Racks



# SITE FURNISHINGS

## Continued

### Pet Waste Stations

Dog waste management is a major challenge when trying to keep your common areas clean and green. Our pet waste stations offer a complete and attractive solution.

- Extruded and cast aluminum construction that will not rust
- Decorative pole and topper
- Stainless steel hardware
- Available in textured black and evergreen powder coated finishes
- Logo and sponsorship signage options are available
- Refill bags and liners available

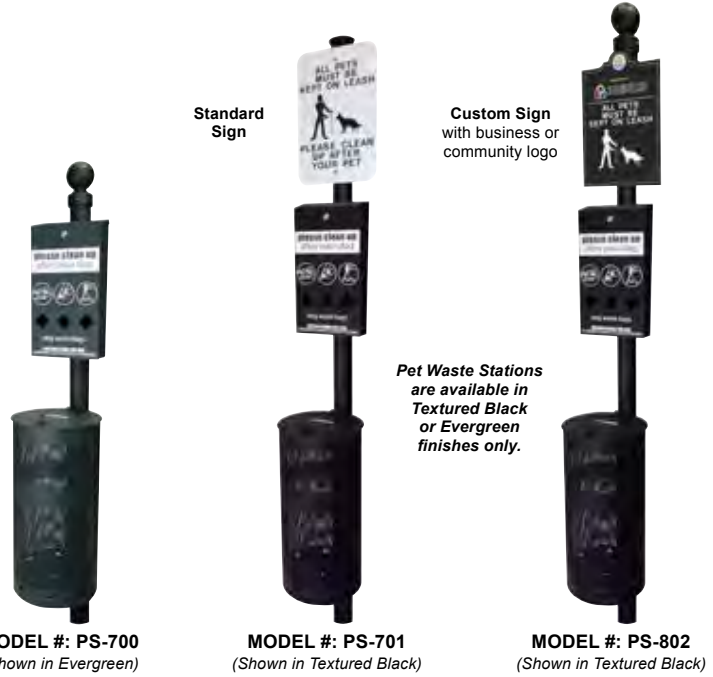

### Bollards

Bollards can be used at key locations to create a sense of separation between pedestrian and vehicular areas and to add visual interest to a streetscape.

Direct burial and surface mount options are available.

#### Crash Tests:

We have not conducted nor do we intend to conduct a laboratory crash test. Bollards are manufactured and designed as a deterrent and precautionary boundary only. We do not boast or claim that the given bollards will withstand any given force or impact liability purposes.



### Message Boards

Our enclosed, weather resistant message board systems come standard with a decorative hood that provides protection from the elements.

Decorative message boards can be coordinated with your traffic poles and/or mailboxes to create a unified look throughout a property. The message boards can be mounted on a single post or a double post system.

Message boards are perfect for home owner associations, apartment complexes or universities.

#### Key Features:

- Rust free aluminum construction
- Lockable doors with keys
- Durable acrylic window(s)



Message board shown with decorative pole, topper and hood



Single Door shown with black finish



Single Door with Header shown with satin finish



Double Door shown with black finish

# COMMERCIAL LIGHTING

We offer an extensive line of commercial lighting designed to add aesthetic appeal to your commercial property or community, while enhancing safety. Choose from our large selection of complete lighting systems, as well as LED bulbs, bases and poles, luminaries and replacement acorn globes.



Model #: MP-412 w/AD / WRB6 / SHD1-PC1023CL / PFIN



Model #: MP-612 w/AD / WRB9 / TSB15 / SHD1-PC1023CL / SR / PFIN



Model #: PSM-MP-612 w/AD / WRB11 / SHD1-AC1026CL-TYPE III / PFIN

## Commercial Lighting Accessories



**P7327**  
Post Mount Double  
Lighting Arm



**W7317**  
Wall Mount  
Lighting Arm

## Replacement Globes



**PC1016CL**  
10 3/4" W x 16 3/4" H  
6" Neck Opening



**PC1023CL**  
14" W x 21 1/4" H  
8" Neck Opening



**PC1026CL**  
16 5/8" W x 27" H  
8" Neck Opening



**PC2020CL**  
15 1/2" W x 20" H  
8" Neck Opening



**AC1026CL-Type III**  
15 3/4" W x 27" H  
8" Neck Opening



**AC1026CL-Type V**  
15 3/4" W x 27" H  
8" Neck Opening

## LED Lighting



**Model Number:**  
B-127-E26 (15w Bulb)  
2 3/4" Dia. x 5" H



**Model Number:**  
B-130-E26 (20w Bulb)  
B-135-E26 (30w Bulb)  
B-140-E26 (40w Bulb)  
3 1/2" Dia. x 6 1/4" H



**Model Number:**  
B-145-E26 (50w Bulb)  
B-153-E26 (65w Bulb)  
3 1/2" Dia. x 8 5/8" H

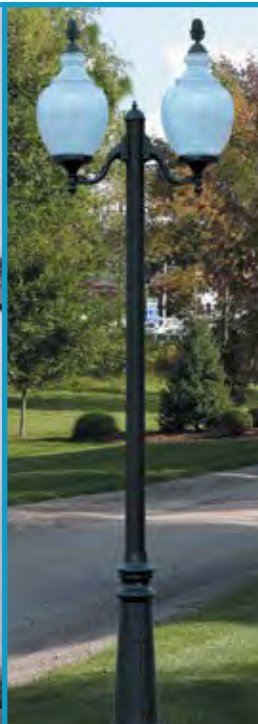

## WHAT OUR CUSTOMERS HAVE TO SAY...

"I can't begin to express my gratitude to Forsite! The signs look beautiful and truly add value to our community..."

- **Western Heights Neighborhood Association**

"We were very pleased with Forsite's willingness to offer suggestions, provided proofs and delivered a very nice finished product."

- **Westview Development Companies, Inc.**

"All of the materials were delivered and installed in a timely manner...The look of our community has been greatly improved due to Forsite's efforts."

- **Addison Trace Community**

"Great addition to the community...have received many compliments...would recommend Forsite to any city considering a streetscape project..."

- **Borough of Sewickley, PA**

"I was very impressed with Forsite's work, plus they brought expertise and alternatives which really helped the board make the right decision. I would recommend Forsite to any community interested in a mailbox or street sign project."

- **Vanguard Management Group**



### General Office Contact Information:

3016 South Third St., Suite 201 Jacksonville, FL 32250  
or PO Box # 51402 Jacksonville, FL 32240

**Toll Free Phone: 1-855-537-0200**  
**[www.mailboxesandsigns.com](http://www.mailboxesandsigns.com)**  
**[customerservice@forsite.us](mailto:customerservice@forsite.us)**